



## User Manual

### MyChron6 – MyChron6 2T

Release 1.00



## Index

• MyChron6 in few words	5
• What is in the kit	6
• Installation and powering	7
3.1 - Installing the RPM cable on a four-stroke engine	7
3.2 - Installing the RPM cable on a two-stroke engine	8
3.3 - Recharge and powering	8
4- Configuration Menu	8
4.1 - Backlight	9
4.2 - System setting	9
4.2.1 – Unit of measure	10
4.2.2 - Drive setup	10
4.2.3 – RPM setup	11
4.2.4 – Temperature setup	11
4.2.5 - Lap time setup	11
4.2.6 – LED setup	13
4.2.7 – Display setup	14
4.2.8 – General setting	16
4.2.10 – System info	16
4.3 – Counters	16
4.4 – Wi-Fi	17
4.4.1 Configuring MyChron6 as an Access Point (AP)	19
4.4.2 – Adding MyChron6 to an existing network	20
4.4.3 – Wi-Fi network settings	21
4.4.4 – The Internet connectivity	22
4.4.5 – Connection issues	22
4.4.6 – Working on Mac™ with virtualized Windows™	23
4.4.7 – Connected device visualization issues	25
4.5 - Bluetooth connection	25
4.6 – Track management	26
4.6.1 - Creating a track with MyChron6	27
4.7 – Language and Time Zone	28
4.7.1 - Language	28
4.7.2 – Time Zone	28
4.8 - Configuration Wizard	29



5- On the Track	30
6 – Data recall	32
6.1 Data Recall in Road racing Mode	32
6.2 – Data recall in Oval racing mode (US version only)	34
7 – Connection to the PC	35
8 – Data download	37
9- Analysis	38
10 – Notification of new available versions	38
11 – Technical specifications and drawings	40

## Introduction

The first My-Chron appeared on the market more than 30 years ago!

The original simple concept of a personal chronograph automatically showing lap times and other important information to the racer remained the core of the system that, in the meantime, has improved and improved till arriving at the actual sixth generation.

Now we are introducing MyChron6, and we are deeply grateful to all our dealers, distributors, friends that have spent their lives on the track, attending our systems, helping everybody to start using them, repairing them when they required to be repaired, giving us important feedback that allowed us to constantly improve them in all these years.

Thank you.



- [MyChron6 in few words](#)

MyChron6 offers the following features:

- **RPM input** from sparkplug cable, for both 2 and 4 cycles engines.
- One or two temperature inputs. It is possible to choose between thermocouple or thermoresistance; the sensors can read **Exhaust Gas**, **Under spark** and **Water Temperatures**
- Through Bluetooth it is possible to read any **heart rate** sensor
- Thanks to an internal 6 axis IMU it is possible to get the **steering wheel angle**
- It samples and shows all parameters coming from GPS, Glonass and Galileo constellations: **speed, position, linear and lateral acceleration** with a precision of one millisecond. The receiver has been specifically tuned for kart races and can thereby stand all lateral and longitudinal accelerations, direction changes and vibrations without problems.
- The GPS receiver is used also for calculating **lap/split times**: the internal database includes more than 2500 tracks, thereby automatically recognizing the track you are racing on, its start/finish line and the possible splits
- All these data are stored in a huge **USB memory card** or in a **4GB internal memory** from which they, can be downloaded on a PC via USB or Wi-Fi and analyzed using AiM Race Studio 3 software
- A 16 grey levels **wide display**
- A configurable RGB **backlight** that, thanks to the light sensor, automatically switches on in low light conditions
- 5 configurable RGB LEDs that you may configure for using in two different ways: they may help you choose the best up-shift moment in case you are driving a gear kart, or you may use them for showing the real-time gap between the current lap and your reference lap.
- 2 RGB alarm LEDs that can be switched on in seven different colours
- A Lithium ions battery that may power your device up to 20 hours.
- A **CAN** expansion bus, for connecting:
  - SmartyCam 3
  - LCU1S Lambda controller
  - MyChron Expansion
  - Infrared temperature controller
- A **Second CAN**, for connecting future external devices

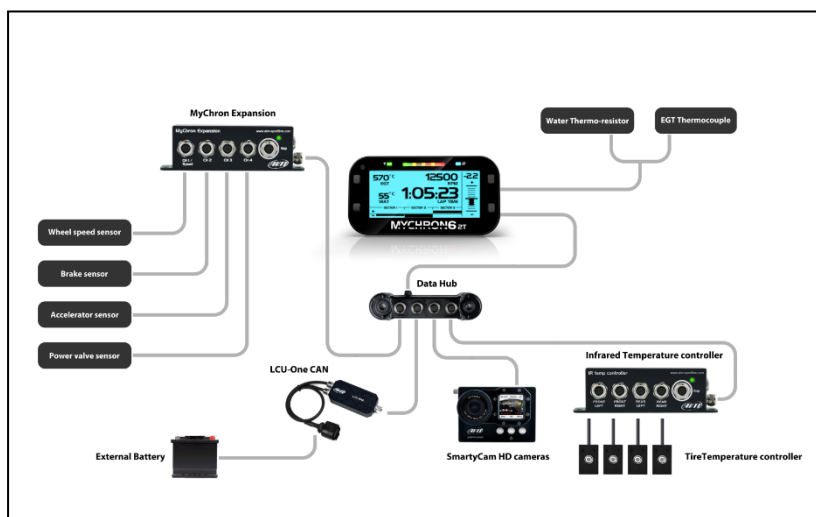



- What is in the kit

MyChron6/MyChron6 2T are available in different kits with and include thermocouples, thermo-resistor or both; the kits include:

- MyChron6 or MyChron 62T
- One or two temperature sensors.
- USB 2.0 A-Type C-Type 100cm cable

#### Optional and spare parts

The following items can be bought as optional or spare parts with the following part numbers.

1- MyChron6 external power cable	V02557020
2- M10 Water thermo-resistor	X05TRM10A4512BPS
3- T12 Exhaust Gas thermocouple	X05TCM12A1175M
4- T12 Long Life Exhaust Gas thermocouple	X05GAS12A4510M
5- M5 Exhaust Gas thermocouple	3CVGAS807
6- 14mm diameter Cylinder Head Thermocouple – Binder connector	X05SOT14A4517BML
7- 14mm diameter Cylinder Head Thermocouple – Mignon connector	X05SOT14A4516MS
8- Patch cable with Mignon connector	V03CCB15M
9- Patch cable with Binder connector	V02PCB15BTR
10- Patch cable 1 thermo-resistor + 1 thermocouple	V02557110
11- Patch cable 2 thermocouples	V02557070
12- Patch cable 2 thermo-resistor	V02557080
13- 7 pins CAN 2 + Lap cable	V02602010
14- 7 pins CAN2 cable	V02602020
15- 7 pins lap cable	V02602030
16- USB 2.0 A-Type C-Type cable	X90TMPC10101
17- 16Gb Mini USB Drive	3IRUSBD16GB

- **Installation and powering**

Your MyChron6 has been designed to be installed on a kart steering wheel. Please install rubber washers above and under your kart steering wheel. When installing the harness be careful not to over tighten the plastic stripes because vibrations can cut the harness sheath and leave the cable long enough to stand the steering wheel angle.

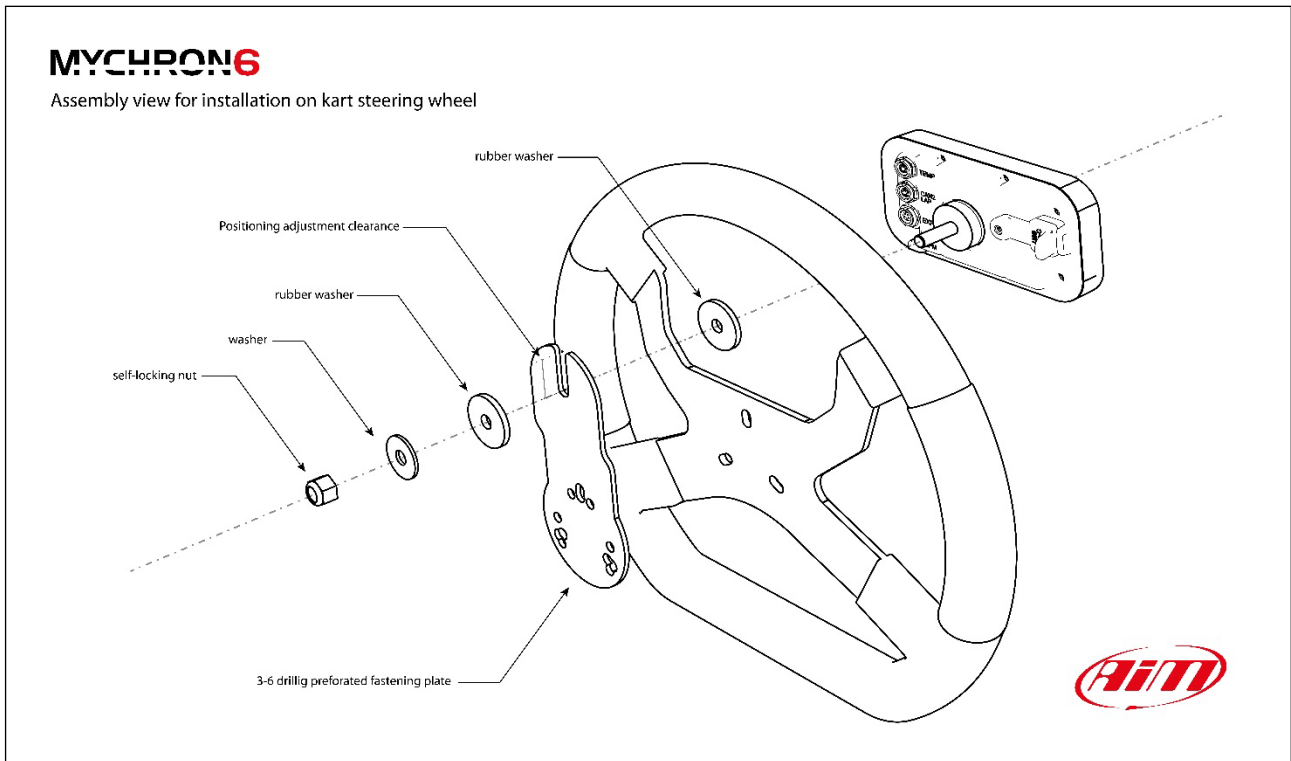

### 3.1 - Installing the RPM cable on a four-stroke engine

A clean RPM signal is the key to a good performance of your MyChron6.

To get a clean signal, it is important for the RPM lead be installed correctly in order to pick up the best signal from the plug wire

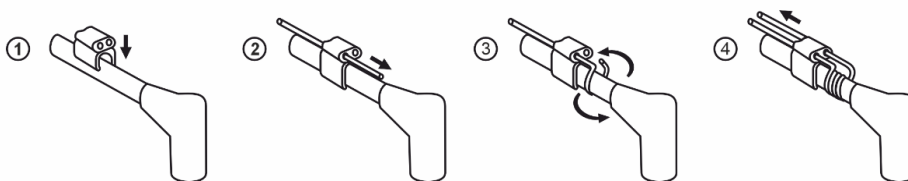

### 3.2 - Installing the RPM cable on a two-stroke engine

Make the RPM cable pass in the clip without wrappings on the spark wire as shown here below.

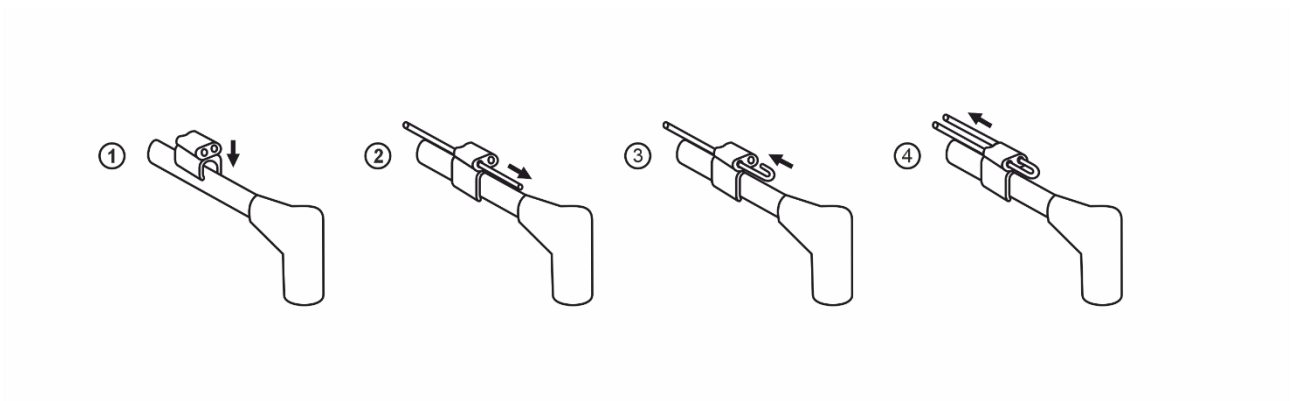

### 3.3 - Recharge and powering

MyChron6 can be charged in two ways:

- through the external power connected to the 5 pins Binder connector placed on the back of MyChron6
- Through the A-Type C-Type USB cable you can connect to a battery charger of at least 2 watt or to your PC

## 4- Configuration Menu

Before using your MyChron6 you need to set some parameters as explained here below. Enter the menu pressing the “MENU” button and this page shows up.



The icons allow you to set your MyChron6:



<p>Backlight</p>	<p>System settings</p>	<p>Counters</p>	<p>Wi-Fi</p>	<p>Bluetooth</p>
<p>Track Management</p>	<p>Languages and zones</p>	<p>Configuration Wizard; <b>starts automatically at first switch on.</b></p>	<p>Clear Memory</p>	

### 4.1 - Backlight

You can set the backlight as:

- “ON”
- “OFF”
- “AUTO”: in this case the light sensor placed on the front of your MyChron6 switches on/off the backlight according to the ambient light level.

Available backlight colours are:



### 4.2 - System setting

Selecting this icon, you enter MyChron6 main configuration page. Here you find RPM, gear, LED, display and lap configuration menus.



The icons are:

 Unit of measure	 Drive setup	 RPM Setup	 Temperature Setup	 Lap Time Setup
 LED Setup	 Display Setup	 General Settings	 System Info	

#### 4.2.1 – Unit of measure

You can set the unit of measure of:

- speed: km/h or mph
- temperature: °C or °F

#### 4.2.2 - Drive setup

Settings are different according to the system version and to the type of race you set.

- direct
- clutch
- gearbox: it needs to fill in highest gear number; for this setting to work properly gear calculation procedure is needed, and this page allows to reset it too
- CVT (Continuously Variable Transmission shaft)

**Gearbox setting** allows to perform and restart gear calculation following these steps.

- fill in highest gear number
- run a learning lap
- if the calculation is not correctly performed press “Reset Gear Calc” and repeat it.

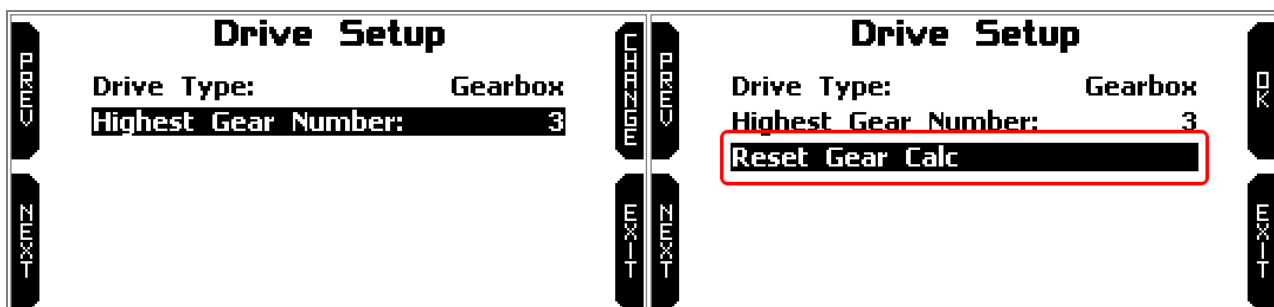

Further information about gear calculation and learning lap procedure are available on the website [www.aim-sportline.com](http://www.aim-sportline.com) – Download Area – Documentation – MyChron6 section.

### CVT (Continuously Variable Transmission) setting

This setting needs the proper speed sensor to be connected to the “CAN2 LAP” connector. Once the sensor is connected, when you select this setting, the channel disables lap time detection and switches to a speed channel.

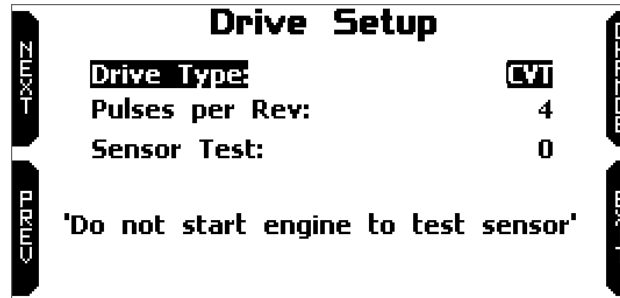

### [4.2.3 – RPM setup](#)

You can set:

- RPM maximum (from 6000 to 24000)
- RPM acquisition frequency (20 or 50 times per second)
- RPM factor (x1, x2, /2, /4, /3)
- RPM can be read 20 or 50 times per second according to your needs: 50Hz reading provides a more accurate signal but produces a bigger datafile that requires more time for the data downloading.
- RPM factor is the ratio between the number of ignitions and the number of crankshaft revolutions. Kart typical setting is “x1” while other installations can need other factors.
- 

### [4.2.4 – Temperature setup](#)

This page allows to set the temperature channel. Available options are:

- **Automatic:** the system automatically detects the sensor functionality, choosing among Exhaust gas, under spark and water temperatures. For automatically detecting the sensor types, the system checks the temperature values, that are in different ranges: this requires a minimum time for allowing the temperatures arrives at their typical values. In case you prefer to immediately have the
- **Manual:** allows the user to select the sensor functionality

### [4.2.5 - Lap time setup](#)

**European version:** you can set different lap management:

- automatic (left image below)

- manual (right image below): you can choose GPS or optical/magnetic receiver

Lap Time Setup		Lap Time Setup	
Beacon Mode:	<b>AUTOMATIC</b>	Beacon Mode:	<b>MANUAL</b>
Lap Display Time:	5 sec	Beacon Source:	GPS
Lap Summary:	Enabled	Track Width:	10
		Blind Time:	3 sec
		Lap Display Time:	5 sec
		Lap Summary:	Enabled

In **automatic** mode MyChron6 recognizes if an optical/magnetic receiver is connected in addition to the integrated GPS. In this case both receivers work at the same time continuously exchanging and comparing information about track finish and split points you cross. You can:

- show lap time when crossing start/finish line for a 3-60 seconds time period.
- enable/disable lap summary visualization when crossing start/finish line; in the US version only what is shown depends on the type of race you set in the Wizard or in the general settings (Road or Oval).

In **manual** mode MyChron6 default setting is GPS lap time but you can also set magnetic/optical receiver (right image below).

Lap Time Setup		Lap Time Setup	
Beacon Mode:	<b>MANUAL</b>	Beacon Mode:	<b>MANUAL</b>
Beacon Source:	GPS	Beacon Source:	<b>OPTIC/MAGN</b>
Track Width:	10	Beacon Segments:	3
Blind Time:	3 sec	Beacon First Seg:	1
Lap Display Time:	5 sec	Blind Time:	3 sec
Lap Summary:	Enabled	Lap Display Time:	5 sec
		Lap Summary:	Enabled

For GPS lap time you need to:

- fill in track width (between 5 and 100m)
- set blind and lap display time (both between 3 and 60 seconds)
- enable/disable lap summary visualization when crossing start/finish line.

For optical/magnetic lap time you need to:

(EU version)

- fill in the number of beacon segments (between 1 and 6)
- set beacon first segment
- set blind and lap display time (between 3 and 60 seconds)
- enable/disable lap summary visualization or not when crossing start/finish line.

(US version)

- set lap display time when crossing start/finish line (from 3 to 60 seconds)

- enable/disable lap summary visualization: as already said the data shown changes according to the type of race that you set.

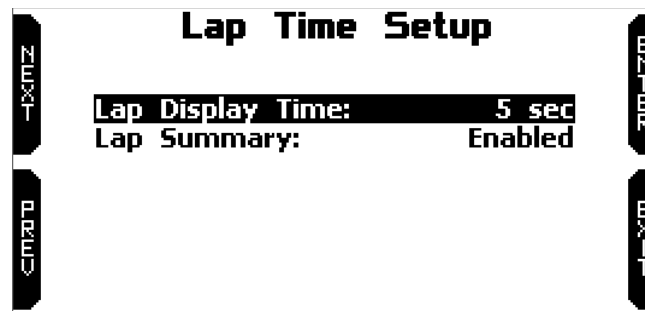

#### 4.2.6 – LED setup

Here you can set:

- the central LEDs bar (**LED Bar**)
- the two lateral LED corresponding to “1” and “2” screen prints (**Alarm LEDs**)

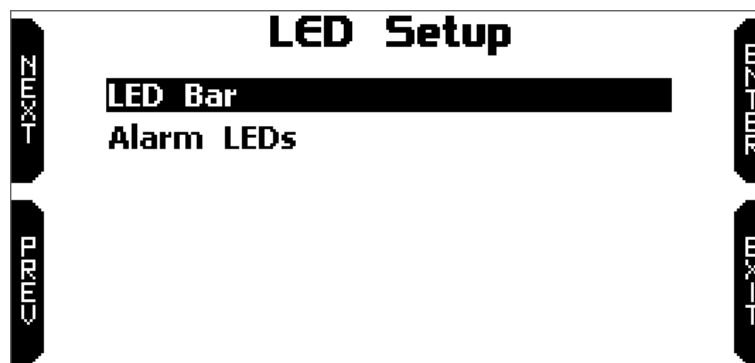

**LED Bar:** manages the central LEDs. Available options are:

- **Lap time**
- **RPM**
- **OFF**

Choosing **Lap time** LEDs will switch on while running and – according to the option selected - can show:

- gap between current lap time and best lap time (Predictive)
- gap between current split time and this split time in best lap (Best Section).

Each of the five LEDs indicates a tenth of a second gap; if lighting green they indicate an improvement while if lighting red they indicate a worsening.

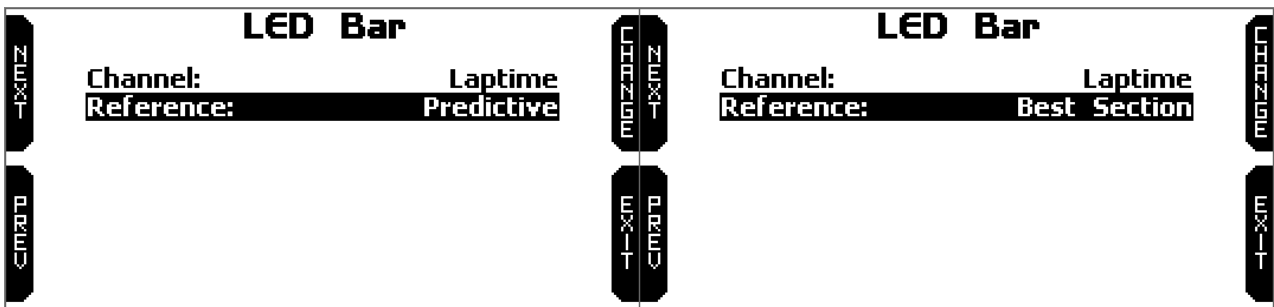

Choosing “RPM” (left image below) you can set RPM threshold value (up to 16.000) that switches on each LED so to know when shifting.

Choosing “OFF” (right image below) the central LED bar is disabled.

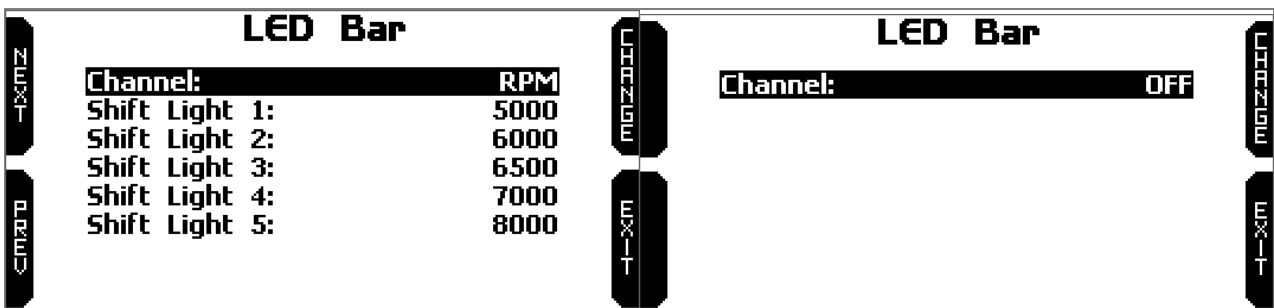

**Alarm LEDs:** manages the lateral LEDs corresponding to “1” and “2” screen prints that can be configured as alarms (left image below).

Entering the page (right image below) you can link each LED to a temperature sensor and set it switching on threshold, LED colour and blinking frequency.

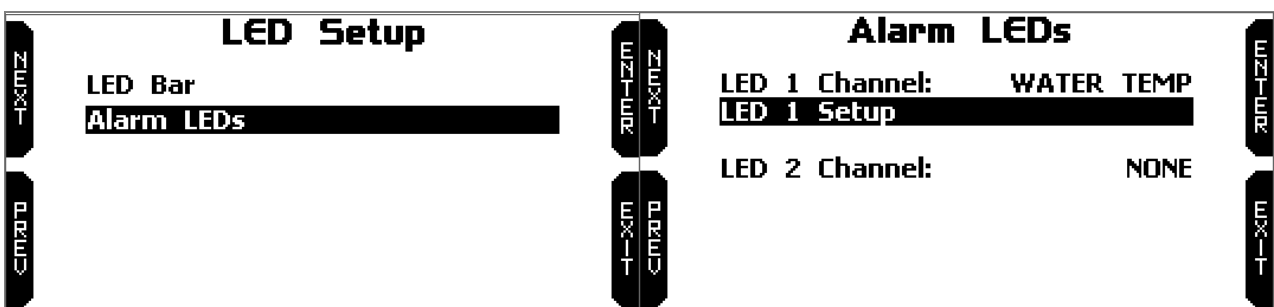

#### 4.2.7 – Display setup

MyChron6 can show up to 8 pages, four of which are **pre-defined** pages and four **custom** pages.

**Pre-defined** pages, enabled by default, are:

- Predictive & Sectors
- Laptime & Sectors
- Heart Rate

- RPM bargraph

In pre-defined pages the options to set are:

- **Enabled:** YES/NO
- **Lap Time format:**
  - **Static:** lap time is shown steady for the entire lap and changes when crossing start/finish line
  - **Rolling:** lap time is shown dynamic for the time period you set in “Lap Time setup” (see related paragraph); afterwards time starts rolling again
  - +/- Best: shows the gap between current lap and the best lap of this session; if the current lap is the new best lap this is automatically updated and becomes the reference for the following laps
  - **Predictive:** it calculates each 50m the predicted lap time using the speed channel and GPS position
- **Split display format:**
  - +/- Best: shows the difference between current split time and best time of that split in the current session (not always related to the best lap)
  - Actual: shows current split time

**Please note:** setting Lap Time format as “Predictive” Split Display format “Actual” is not available

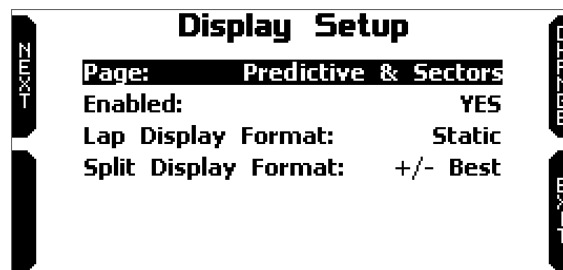

Once **custom** enabled “CONFIG” button top left of the page appears: press it.

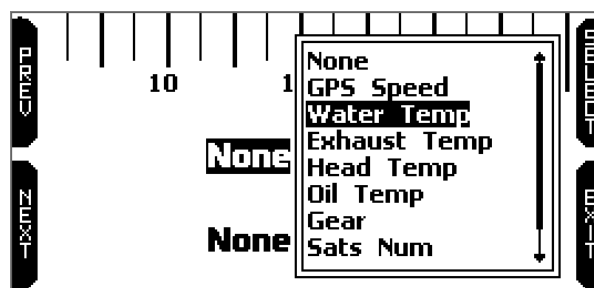

Each custom page can show up to four fields. Pressing “SELECT” you can choose the channel to show in each field. The only field that can show lap time in different formats is bottom right one (right image below).

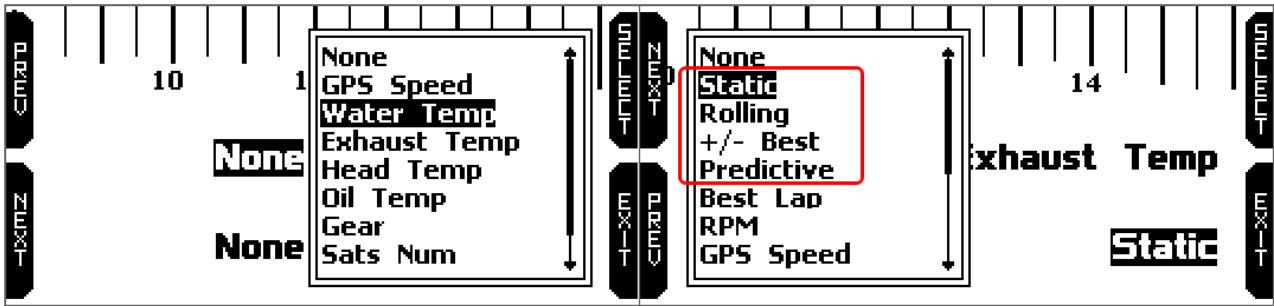

#### 4.2.8 – General setting

In the **European version** you can enable/disable GPS.

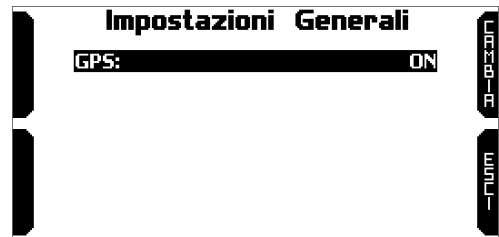

In the **US version** you can select the type of race choosing between oval and road and set the lap time format as well as reset best time.

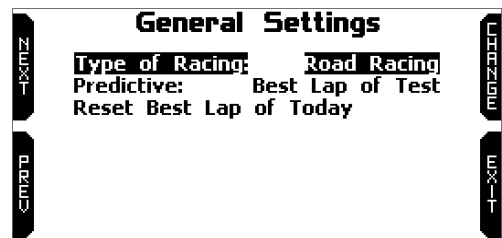

#### 4.2.10 – System info

This page shows serial numbers as well as firmware and boot version of your MyChron6.

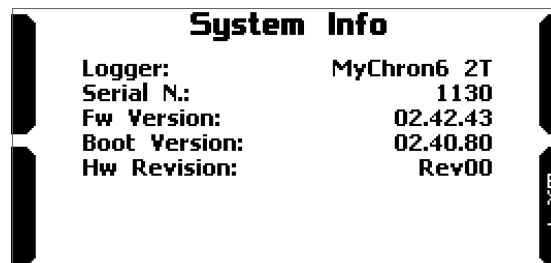

#### 4.3 – Counters



This page manages the 4 resettable odometers of MyChron6. The system odometer is not resettable and so it is not selectable.

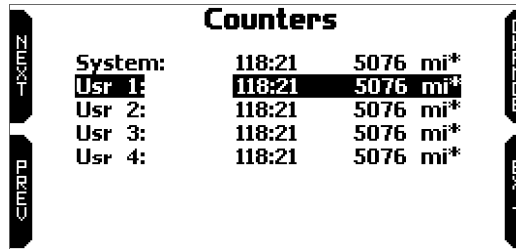

Each odometer can be activated or stopped and reset. Select the odometer you want to manage and press “CHANGE”:

- to stop it select “Status” and press “CHANGE”: status becomes “STOP” (left image below)
- to reset the odometer, select “Clear” and press “CHANGE” (left image below)
- pressing “EXIT” you go back to counters page and the counter you have cleared shows 0 km.

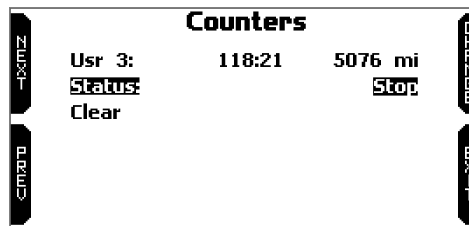

#### 4.4 – Wi-Fi

Here you can manage Wi-Fi as well as reset its configuration.

In the **US version** available Wi-Fi modes are:

- ON: always active
- Auto: active only when the speed is less than 5 mph
- OFF (default)

In the **European version** available Wi-Fi modes are:

- Auto: active only when the speed is less than 5 km/h
- OFF (default)

In this version “ON” mode is not available.

“**Wi-Fi Reset CFG**” option allows to reset Wi-Fi configurations and is very useful if you do not remember Wi-Fi password

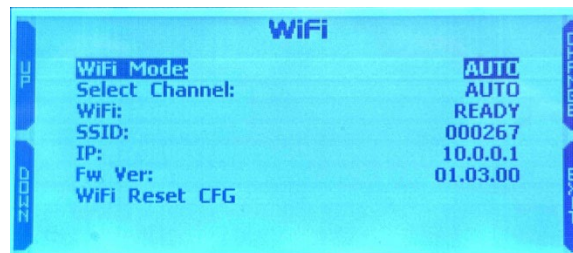

MyChron6 Wi-Fi configuration can be made only using Race Studio 3 software. Two possible Wi-Fi modes are available:

### 1 – As an Access Point (AP – default setting)

This is the ideal configuration if you have one only device and one only computer. In this situation, your MyChron6 creates a Wi-Fi network and works as an Access Point you can connect your PC to.

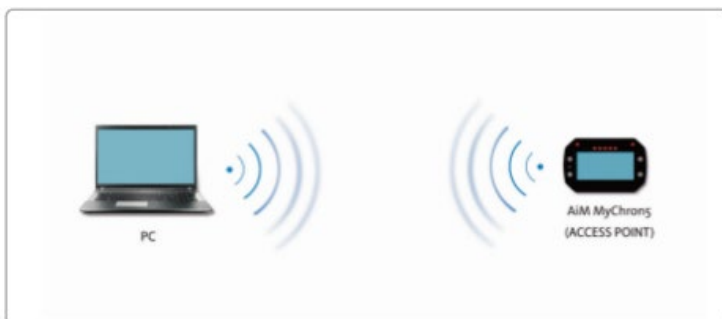

### 2 – Existing network (to connect to an existing Wi-Fi network – WLAN)

This mode is more complex and implies an external access point (AP) but it is also more flexible and powerful because allows you to communicate with more than one device and with more than one computer in the same network. MyChron6 and the PC must connect to an existing Wi-Fi network made by a device that works as an external Access Point.

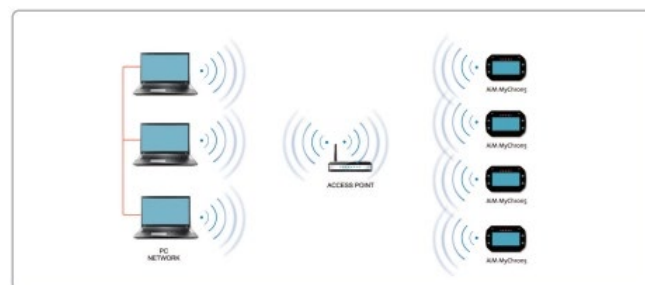

When working in WLAN mode MyChron5 has two available security levels:

- network authentication: network password
- device authentication: MyChron6 password

Both levels allow you to use different strategies. A PC in WLAN, for example, can see several AiM devices but can communicate only with those he knows the password of. If you forget the password, you can reset Wi-Fi configuration from MyChron5 menu as explained at the beginning of this chapter

#### 4.4.1 Configuring MyChron6 as an Access Point (AP)

This is MyChron6 default configuration and is the easiest and most direct connection mode, ideal if you want to communicate with one MyChron6 using one PC. It is free and so completely accessible by anyone. AiM suggests to set an access password.

- To establish a Wi-Fi connection:
- ensure that the Wi-Fi is enabled
- read your MyChron6 name in the bottom line of the display main page (001130 in the image).



- run RaceStudio 3
- click Wi-Fi icon and select your device
- in a few seconds, the connection is established

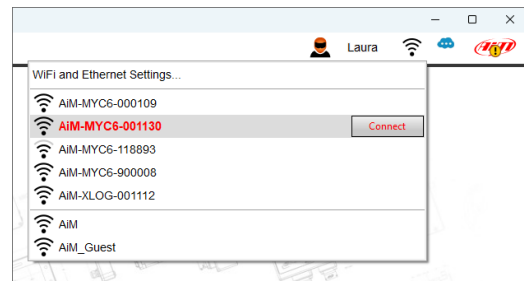

To set other parameters create a unique password to protect the device/ network. With a password the communication is safe and encrypted using WPA2-PSK standard.

Characters allowed in the password are all letters, also capital, all digits and these characters: ‘+ - \_ ( ) [ ] { } \$ % ! ? ^ # @ \* \ \ " = ~ . : ; / % ". “Space” type can be used if it is not the first one because this could cause incomprehension in some Windows™ versions.

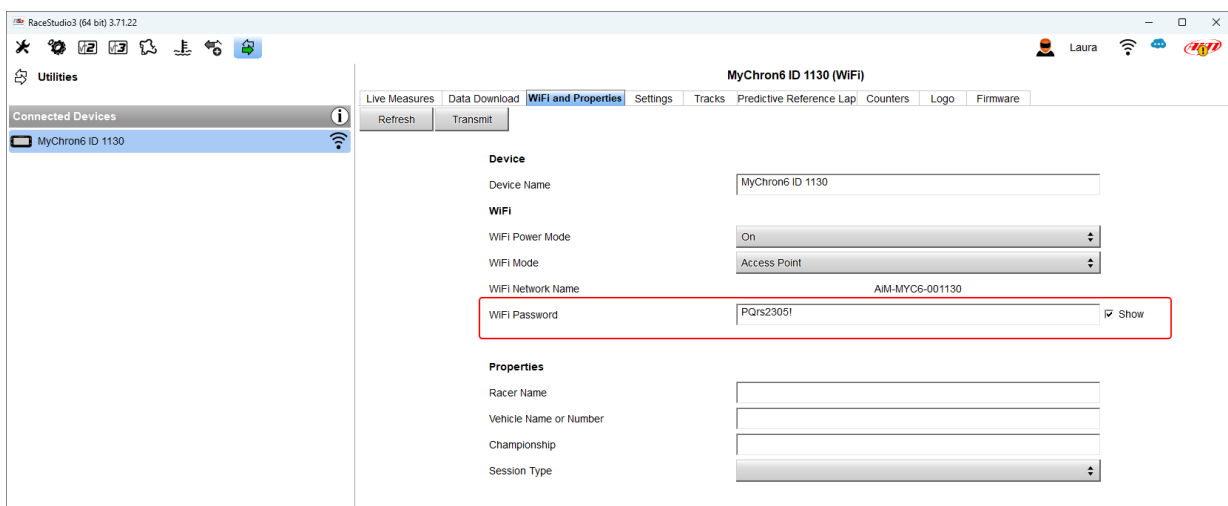

This AP or SSID name is unique for your device. An example of name is:” **AiM-MYC6-001130**” where:

- “AiM” is the prefix of all AiM devices
- “MYC6” is the device type identifier

- “001130” is the device serial number assigned by the factory.

To make your device more recognizable you can add a name to the SSID. The limit is of eight characters. Allowed characters are all letters, capital too, all digits and these characters: ‘+ - \_ () [] {}!’. “Space” type can be used if is not the first for not to cause incomprehension in some Windows™ versions.

Adding, for example the driver’s name, John Hawk, the network name (SSID) becomes: **”AiM-M6-001130-John Hawk”**.

Once all parameters set click “Transmit”. MyChron6 reboots and is configured with the new parameters. If MyChron6 is protected by a password, as recommended, Race Studio3 will ask that password to authenticate.

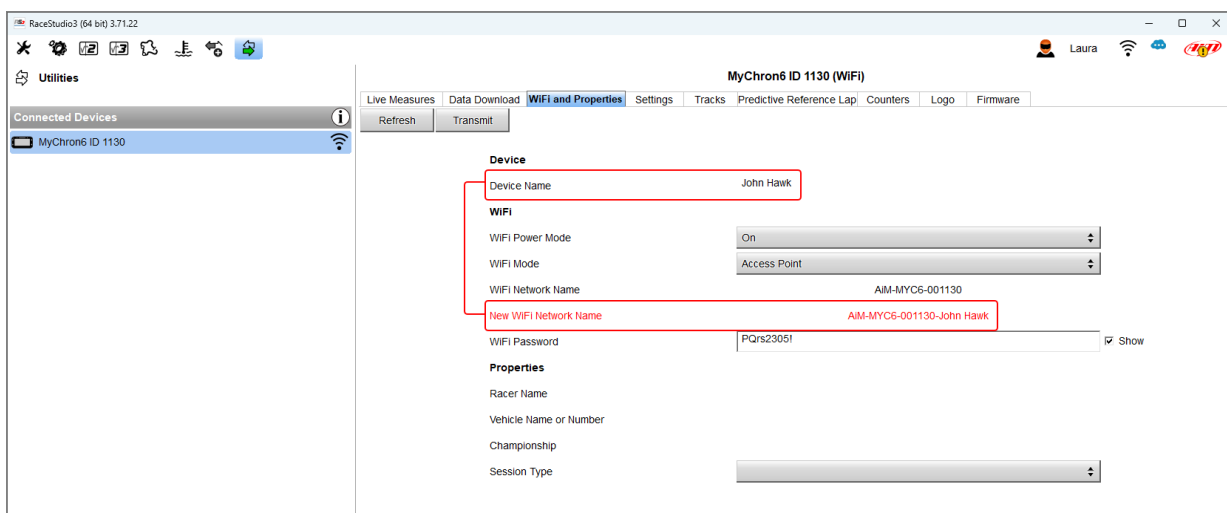

**Please Note:** the same Wi-Fi connection can be created with the operative system tool. Once the device has been authenticated in the Wi-Fi network you can communicate with it using Race Studio 3.

#### 4.4.2 – Adding MyChron6 to an existing network

This situation is ideal for a team with multiple drivers and staff members and is desired to communicate with one or more AiM devices using the same PC network. Each MyChron6 can have its password that adds another security and privacy level to the network.

Race Studio 3 will show all MyChron6 connected to the same network under “Connected devices” label, bottom left of the software page: click your device.

Enter “Wi-Fi and properties” tab and set it on “Existing Network”; fill in network name, network password and device password.

Transmit the network settings to your device clicking “Transmit”: your device reboots and joins that network.

**Please note:** the only admitted password are those following WPA2-PSK standard.

To complete this procedure use Race Studio 3 software as here explained.

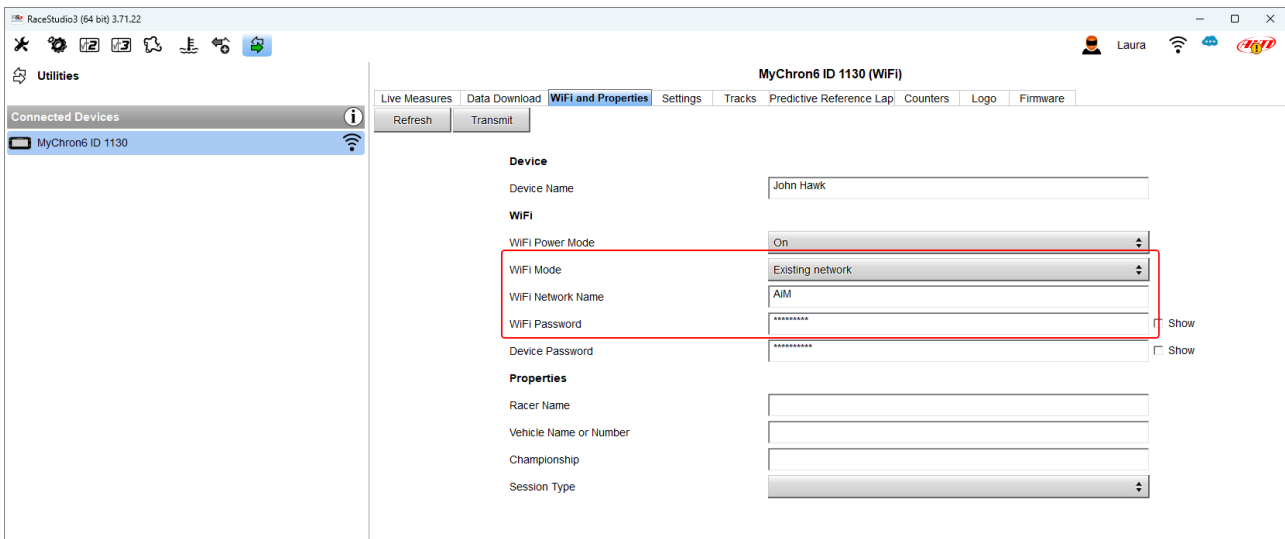

Here above you see a device “MyChron6 ID 1130” that switched from AP to Existing Network. Network name is “AiM” and does not work with free access because is protected by a password.

To obtain connectivity on the device the PC has to be authenticated to the network. When the PC is authenticated to the network called “AiM” it can see all devices configured to access the same network.

### 4.4.3 – Wi-Fi network settings

In this chapter, you find a short description of how to configure a WLAN including AiM devices and a PC. Here below is an example of configuration.

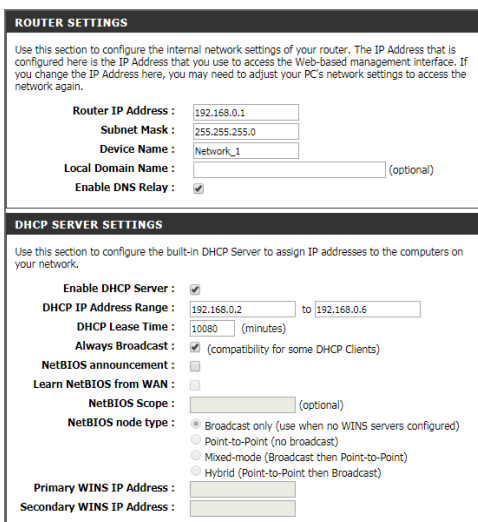

For better network performance, we suggest the use of a network device equipped with a DHCP server and using 3x3 MIMO technology like, for example a Linksys AS3200. To maximize the bandwidth, you should not allow the Internet on this WLAN; this means the DHCP server should be configured without any DNS address nor gateway by default.

The parameters for the device network configuration in this example are:

**Wireless network name: network\_1**



It means that the WLAN network name is “network\_1.” A PC has to be authenticated in this network to interact with any AiM device of this network.

**Gateway address: 192.168.0.1**

primary DNS server: 0.0.0.0

secondary DNS server: 0.0.0.0

(These settings prevent Internet connectivity on this WLAN.)

**Subnet mask: 255.255.255.248**

Enable DHCP server: yes

DHCP IP address range: 192.168.0.2 to 192.168.0.6

These settings enable a DHCP server running on this WLAN and provide an IP address in a 2-6 range. This means that this network allows 5 network hosts.

The number of devices on a WLAN network depends on the subnet mask. Here below you see typical examples of network masks and IP addresses range.

The configuration in bold is the one we suggest (if a greater number of devices is not needed), being the one that makes it easier and quicker for Race Studio 3 the identification of the devices in the network.

<b>Subnet mask:</b>	<b>IP address range:</b>	<b>Number of devices:</b>
255.255.255.0	192.168.0.1 – 254	254
255.255.255.128	192.168.0.1 – 126	126
255.255.255.192	192.168.0.1 – 62	62
255.255.255.224	192.168.0.1 – 30	30
255.255.255.240	192.168.0.1 – 14	14
<b>255.255.255.248</b>	<b>192.168.0.1 – 6</b>	<b>6</b>

#### 4.4.4 – The Internet connectivity

For an optimal speed of your AiM device(s) we recommend not allowing the Internet on the same network and setting the WLAN in the same way. You can of course allow Internet access on your network, but this would degrade communication. This slightly slower speed can be suitable for your needs, but you can also have a second Wi-Fi connection using additional hardware (NIC). This configuration would provide an optimal speed of the data network of your AiM device(s) and at the same time would provide internet connectivity with the second NIC.

#### 4.4.5 – Connection issues

It can occur that MyChron6 is correctly connected to Race Studio 3 via Wi-Fi, but the user interface does not show it. This may be because the Wi-Fi port setting is set with a static IP. To switch it to dynamic (DHCP):

- open “Network and sharing center” in the Windows™ research engine
- right click on the Wi-Fi connection and a panel shows up

select “Properties” option

double click on “Internet Protocol version 4 (TCP/IPv4)”

verify that option “Obtain an IP address” is active

#### 4.4.6 – Working on Mac™ with virtualized Windows™

Race Studio 3 only works on Windows™ operating systems; Mac users can use a virtualized Windows™ machine.

The main problem is that the host OS (Mac) must share its Wi-Fi interface with the virtualized operative system (Windows) as Ethernet interface and not as Wi-Fi interface.

Configuring Parallels(™)

Select “Configure...” in Parallels “Menu”.

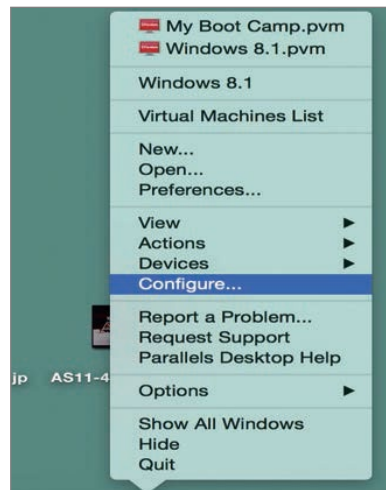

Press “Hardware” – top on the page that shows up – and select “Network” in the drop-down menu on the left.

Right on the configuration panel set "Type" field on “Wi-Fi”.

Then select the device you want to communicate with.

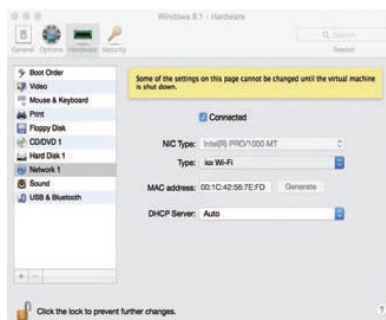

To ensure that the communication works select “Open Network preferences...” menu.



Verify that the status in the window that shows up is “Connected” and that the IP address associated is, for example, 10.0.0.10 (could be 10.0.0.11, 10.0.0.12, or generically 10.0.0.x).

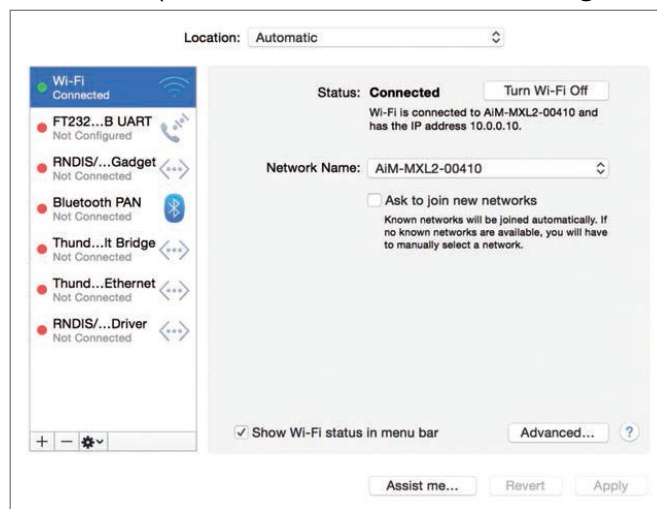

To enable Race Studio 3 correctly working on a Mac with virtualized Windows™:

- press Wi-Fi icon
- select “Wi-Fi and Ethernet Settings” option
- enable the top checkbox



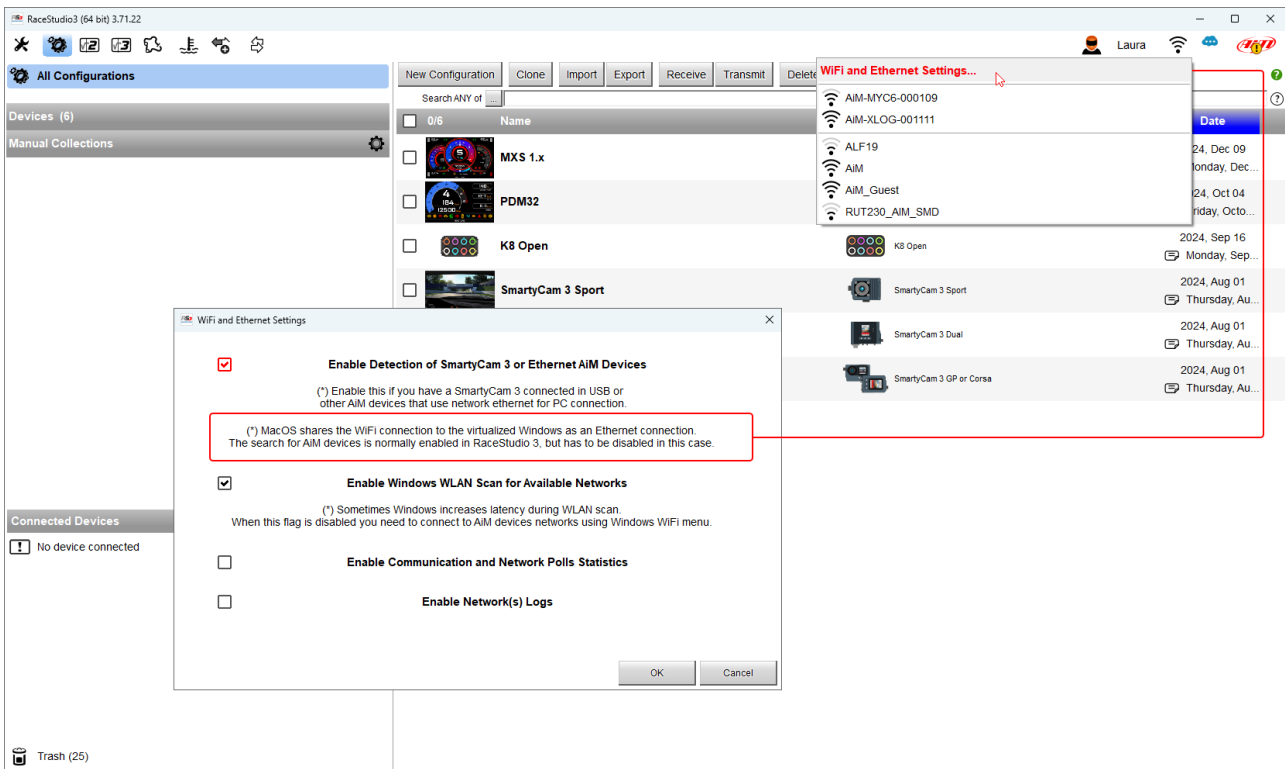

#### 4.4.7 – Connected device visualization issues

It may occur that **using Race Studio 3 on an iMac with virtualized Windows** the device connected via Wi-Fi takes some time to be shown in the network or is not shown at all. This is why we always suggest using a Wi-Fi (WLAN) router.

This router works as an Access Point allowing more external devices to connect to its network. MyChron6 Wi-Fi configuration is to be set on Existing Network as explained in the related paragraph.

It may also occur that, **updating Windows to 11-24h2 version** no Wi-Fi network is available. This is due to new privacy controls. Please click [here](#) to solve this issue.

It is possible to set the time and date by hand and show them in different formats.

#### 4.5 - Bluetooth connection

MyChron6 features a Bluetooth communication protocol that allows us to connect with external devices.

Only the heart rate monitor, of every brand, is actually enabled, but other ones will be added in the future. To connect the device:

- Set “Bluetooth” ON

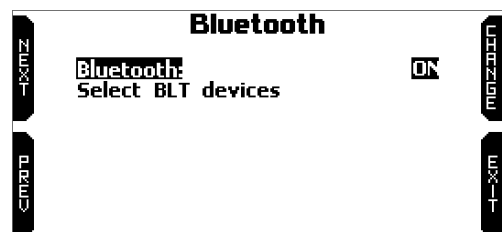

- Select Bluetooth device



- MyChron6 enters device page and shows all available devices as “ON”: press “OK”

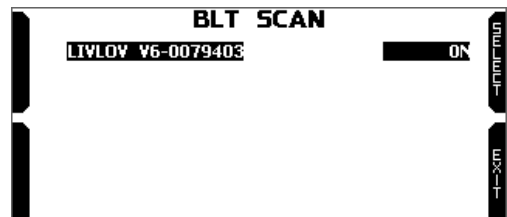

- the system asks for confirmation; pressing “YES” MyChron6 reboots, and the device is connected via Bluetooth.

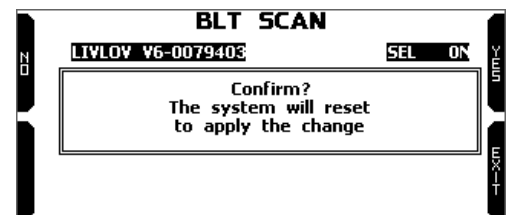

- Once a device is selected MyChron6 stores it in the list of available devices: if selected, the data read from that device may be shown in a Display Custom Page and stored for future analysis in the AiM Analysis software RaceStudio3.

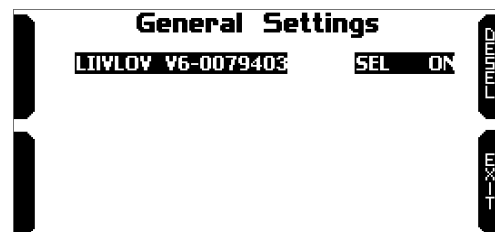

## 4.6 – Track management

MyChron6 built-in GPS receiver is used for:

- Lap Time calculation
- Speed calculation
- Predictive lap time calculation
- Position on the track in analysis

To calculate these data the system needs the following information about the racetrack:

- start/finish line coordinates
- possible magnetic strips coordinates

MyChron6 comes with a long list of the world main kart tracks. The tracks are constantly updated by our technicians and automatically loaded to your PC when running RaceStudio 3 Analysis Software if a connection to the Internet is available.

MyChron6 provides two track selection modes: automatic and manual.

#### Automatic:

MyChron6 automatically recognizes the track you are running on, loads the start/finish line and the possible split coordinates and calculates lap and split times without optical/magnetic receiver.

This is the best mode in most cases.



#### Manual:

allows to manually select the track from the internal database.

Scrolling to Track Selection “Change” button switches to “Enter”: press it and select the track to set.

This mode is preferred when multiple track configurations are available nearby. In this case MyChron6 would anyway recognize the track but would need at least one complete track lap.

To be ready from the first lap manual mode would be helpful.

Scrolling the list of available tracks available options are:

- nearest: shows only tracks in a 10 km distance
- all: shows all tracks stored in the system in alphabetical order
- custom: shows only the tracks previously created by the user (learning mode)

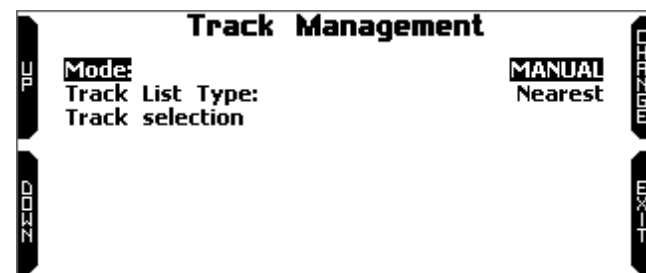

#### [4.6.1 - Creating a track with MyChron6](#)

In case the system is running on a track NOT included in MyChron6 database the device switches to “learning” mode and behave this way:

- starts sampling all track points
- detecting that is crossing the same points for the second time it realizes that the track is closed and sets a temporary start/finish line showing lap time each time it crosses that point;
- at the end of the session the system shows the track map with start/finish line: start/finish line can be moved using MyChron6 lateral buttons
- it is possible to add this new map to MyChron6 database, modify start/finish line coordinates, name the track and transmit it to the PC at first PC- MyChron6 connection.

For further information about track management with RaceStudio 3 refer to “Track Manager” user manual you find in download area /software/Rac Studio 3/documentation of: [www.aim-sportline.com](http://www.aim-sportline.com).

## 4.7 – Language and Time Zone

This menu allows us to set:

- Language
- Time zone



### 4.7.1 - Language

Available languages are:

- English
- Italian
- Deutsch
- Spanish
- French
- Dutch
- Danish
- Portuguese
- Japanese
- Czeck

To select the desired language simply press “Change” button and then “Exit”.

### 4.7.2 – Time Zone

The Time and Date, that will be associated with all your tests and data, are, by default, obtained from the GPS messages.

Available options are:

- Time format: 12H or 24H

- Date format: MM/DD/YY or DD/MM/YY or YY/MM/DD
- Date Time Sync: the system can synchronize its date and time.
  - by GPS Track: time zone is automatically synchronized as MyChron6 receives the GPS signal (default)
  - Manual or
  - by PC: time zone is automatically synchronized as MyChron6 is connected to a PC.

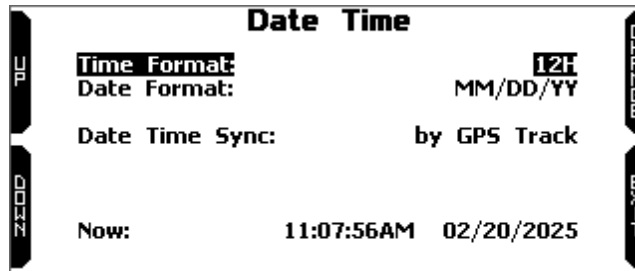

Your MyChron 6 will correct that information automatically setting the Time Zone and, in case, the Daylight-Saving Time.

#### 4.8 - Configuration Wizard

Configuration wizard starts automatically at the very first switch on.

It helps you setting your MyChron6 main parameters:

- Language
- temperature measure unit (Fahrenheit or Celsius)
- speed measure unit (mph or km/h)
- RPM range
- drive setup (direct, clutch or gearbox)
- **type of race: Road racing or Oval** (this choice is only available in the US version)

Road and oval racing show different information when crossing the start/finish line and at data recall. When crossing start/finish line:

In **Road Racing** MyChron6 shows:

- max/min temperature(s) values
- max/min RPM values
- lap number
- lap time

<b>51</b> °C MAX WAT <b>46</b> °C MIN WAT	<b>15328</b> MAX RPM <b>8152</b> MIN RPM
<b>7</b> <b>0:48.02</b>	

In **Oval Racing** MyChron6 shows:

- max/min temperature(s) values

<b>51</b> °C MAX WAT <b>46</b> °C MIN WAT	<b>1590</b> DROP RPM
<b>BEST 0:48.02</b>	

- RPM drop (difference between max and min RPM values)
- lap time

## 5- On the Track

This is the first page that appears switching MyChron6 on, and automatically disappears when the kart starts moving.

It shows:

- On the left, the selected track; you can select a new track manually (menu/track management) or automatically.
- On the right, the satellite bar (visible satellites and signal level of each one). To recall it press (“>>/OFF”) button in correspondence of “TRK” label in MyChron6 home page.

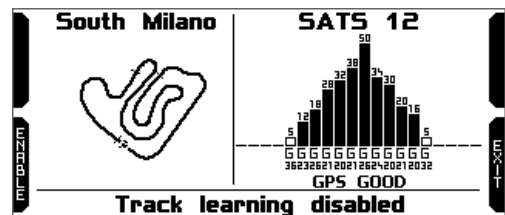

Some MyChron6 pages are available for online visualization. To scroll them, press “ON/VIEW”.

Pages can change according to the device configuration: go kart or shifter kart, possible expansions, SmartyCam, etc.



Some available pages are:

### Predictive page

Beyond the usual values of RPM, Temperature and Lap Time, on the right of the display you have a useful graphical indication of the predictive lap time: if the bar moves toward the high, you are improving your performance.

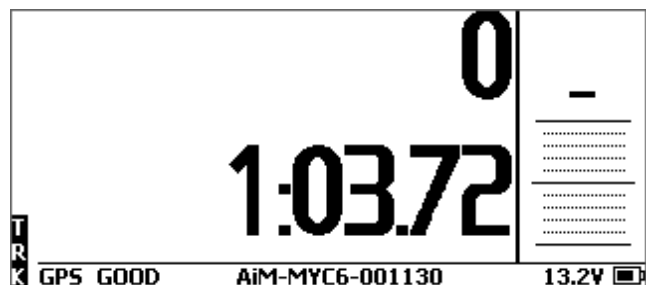

“Cross” page

It shows:

- Lap/split time top left
- Lap time visualization top right  
(predictive in the image below on the right)
- 3 custom fields:
  - Central
  - bottom left
  - bottom right

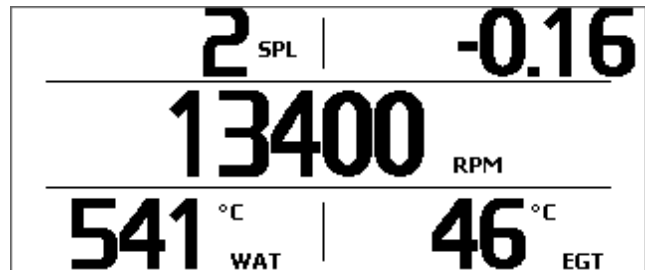

you can select the data to be shown in these fields: press “Select” button and select the channel to display.

### “RPM Bargraph” page

It shows:

- RPM bar graph, whose range has been set in “RPM setup”
- RPM value on the right of the display
- Temperature value(s) on the left part of the screen
- lap time information (actual, rolling or predictive). This information is shown for the period you set in “Lap time setup”

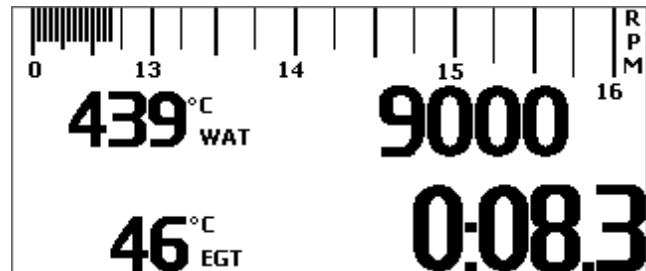

## 6 – Data recall

At the end of the test you can recall sampled data pressing **MEM/OK**. Data recall is different according to your MyChron6 version and to the available types of race.

In the **European** version, the only available racing mode is:

- road

In the **US** version, the racing modes can be:

- road
- oval

### 6.1 Data Recall in Road racing Mode

In Road racing mode data recall shows these pages.

- If your last test is at least 24 hours old you can enter the summary page and select the day you want to see. Press “ENTER”

**TEST SESSIONS**

- 11/21/2024: South Milano
- 11/20/2024: South Milano
- 11/10/2024: South Milano
- 11/04/2024: South Milano

- Then select the test.

**11/21/2024: South Milano**

Speed Race South Milano

In each box you see:

- test time
- number of laps
- best lap time.

11/21/2024: South Milano		
11:12AM 5 Laps B 1:03.72	10:12AM 7 Laps B 1:07.27	09:42AM 4 Laps B 1:04.25

Press “ENTER”

The first page shows:

- The Three Best Lap times
- max/min RPM, speed and temperature values.

Press “PAGE”.

11/21/2024 11:12AM					
MAX RPM		MAX SPEED		MAX TEMP	
14962		121		557 45	
Lap	Best Laps	RPM	km/h	WAT	EGT
<b>4</b>	<b>1:03.72</b>	14202 7574	121 38	556 405	45 43
<b>3</b>	<b>1:04.72</b>	14962 7620	120 40	557 408	44 41
<b>2</b>	<b>1:05.96</b>	14112 7533	119 39	551 386	42 39



The page shows:

- the three best split times only if they have been set in Race Studio 3 or detected by magnetic strips
- the three best rolling lap
- the three best theoretic laps

Press “PAGE”.

Best Lap: 4 1:03.72 <sup>2</sup>			
#	Split Times	Lap Rolling	Lap Theoretic
1	0:14.30	4 0:14.30	4 0:14.30
2	0:04.49	4 0:04.49	4 0:04.49
3	0:44.93	4 0:44.93	4 0:44.93
<b>1:03.72</b>		<b>1:03.72</b>	<b>1:03.72</b>

This page is a histogram test summary. Moving the cursor left and right you can see all laps and select the one you want to see.

Press “PAGE”.

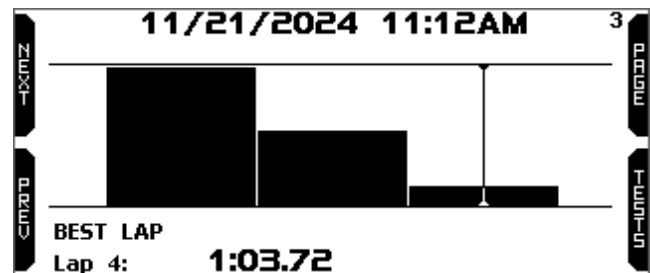

This page shows:

- best lap time top left
- split times of the best lap
- max/min RPM and speed values
- max/min values set in custom page (Water and Exhaust temperatures in the example on the right)

Lap 4 <sup>4</sup>		
Lap Time	RPM	km/h
<b>1:03.72</b>	14202 7574	121 38
1 0:14.30	WAT	EGT
2 0:04.49	556	45
3 0:44.93	405	43

This page shows the RPM graph of the lap, speed value in the point where the cursor is placed and the temperature values of the channels set to be shown.

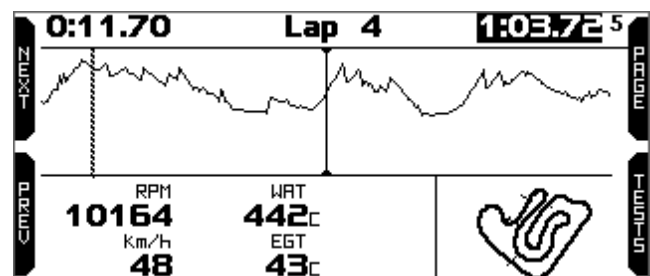

Pressing “Page” MyChron6 comes back to the first data recall page.

## 6.2 – Data recall in Oval racing mode (US version only)

In Oval racing mode data recall shows these pages.

If your last test is at least 24 hours old you can enter the summary page and select the day you want to see.

TEST SESSIONS	
<b>27/03/2021: LowCountryK</b>	
TODAY: Varano	
14/02/2020: Varano	

Press “ENTER”.

Now you can choose the test.

In each box you see:

- test time
- number of laps
- possible “yellow flag” laps
- best lap time.

27/03/2021: LowCountryK		
21:46 10 Laps 4Y B 0:12.86	21:26 32 Laps 9Y B 0:12.03	20:43 32 Laps 9Y B 0:12.04
21:46 32 Laps 9Y B 0:12.03	21:46 4 Laps B 0:32.25	

Press “ENTER”.

If you just finish the test the first page you see is the one here on the right.

The page shows the three best laps of that test with max/min RPM values and RPM drop.

27/03/2021 21:46			
MAX RPM	MAX SPEED		
6063	89		
Lap	Best Laps	RPM	DROP
<b>26</b>	<b>0:12.03</b>	5958 5470	488
<b>25</b>	<b>0:12.09</b>	5924 5516	408
<b>13</b>	<b>0:12.09</b>	6018 5438	580

Press “PAGE”.

This page is a histogram test summary. Moving the cursor toward right and left you can see all lap times.

Bottom on the page you see best lap time with its number.

Laps labelled “Y” are “Yellow Flag” laps.

Press “PAGE”.

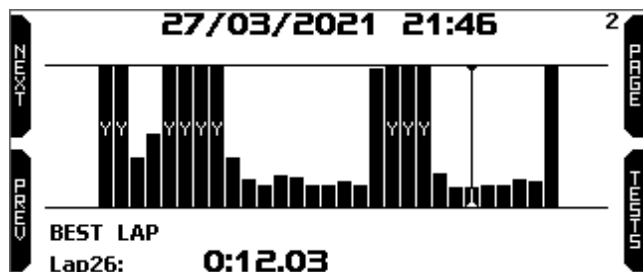

This page is a laps summary with the selected one highlighted.

It shows lap times, max/min RPM values and RPM drop.

Press “PAGE”

27/03/2021 21:46			
Lap	Lap Time	RPM	DROP
24	<b>0:12.46</b>	5853 5184	669
25	<b>0:12.09</b>	5924 5516	408
26	<b>0:12.03</b> B	5958 5470	488
27	<b>0:12.11</b>	5955 5498	457

This page shows the lap playback with your vehicle that moves on the track. Press “SLOW” to reduce the vehicle speed.

Press “PAGE”.

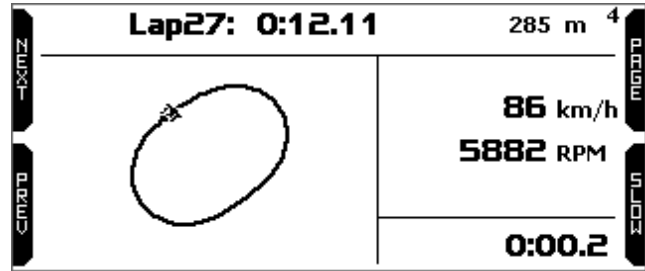

This page shows the lap sectors with max speed and related RPM values.

Press “PAGE”.

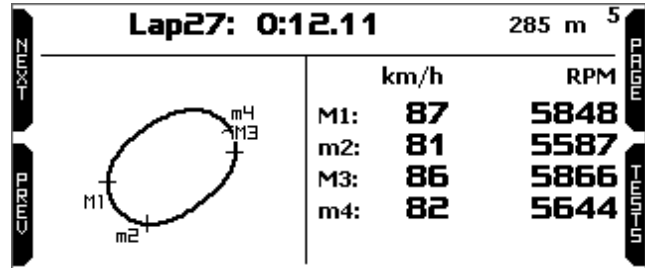

“Grip” page shows the lateral grip in feet/sec<sup>2</sup> of the two turns and the grip average value (AVG).

Pressing “PAGE” you come back to the first data recall page.

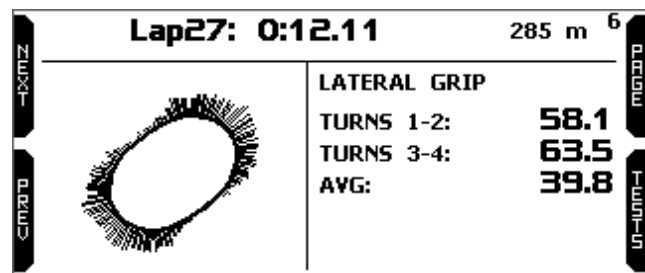

Pressing “Tests” from any page MyChron6 comes back to test summary page.

## 7 – Connection to the PC

You can connect MyChron6 to a PC via Wi-Fi or via USB through the USB cable you find in MyChron6 kit. To connect MyChron6 via Wi-Fi:

- check that MyChron6 Wi-Fi is set on “AUTO” (all versions) or on “ON” (US version only)
- read your MyChron6 name – mid of MyChron6 home page bottom line – look for it in “System Information” page.



or

- Click Race Studio 3 Wi-Fi icon and select your MyChron6

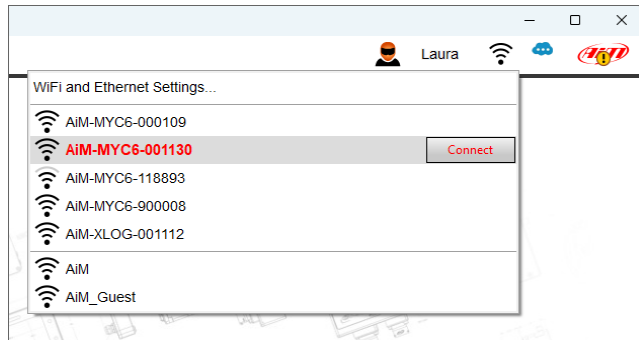

- Click devices icon top left of the software bar
- Click on the device on the left of the software view

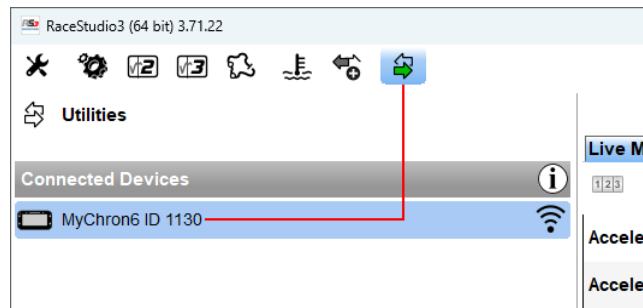

The software enters Live Measures tab as shown here below.

**Please note:** this view can change according to the features available when your MyChron6 has been produced.

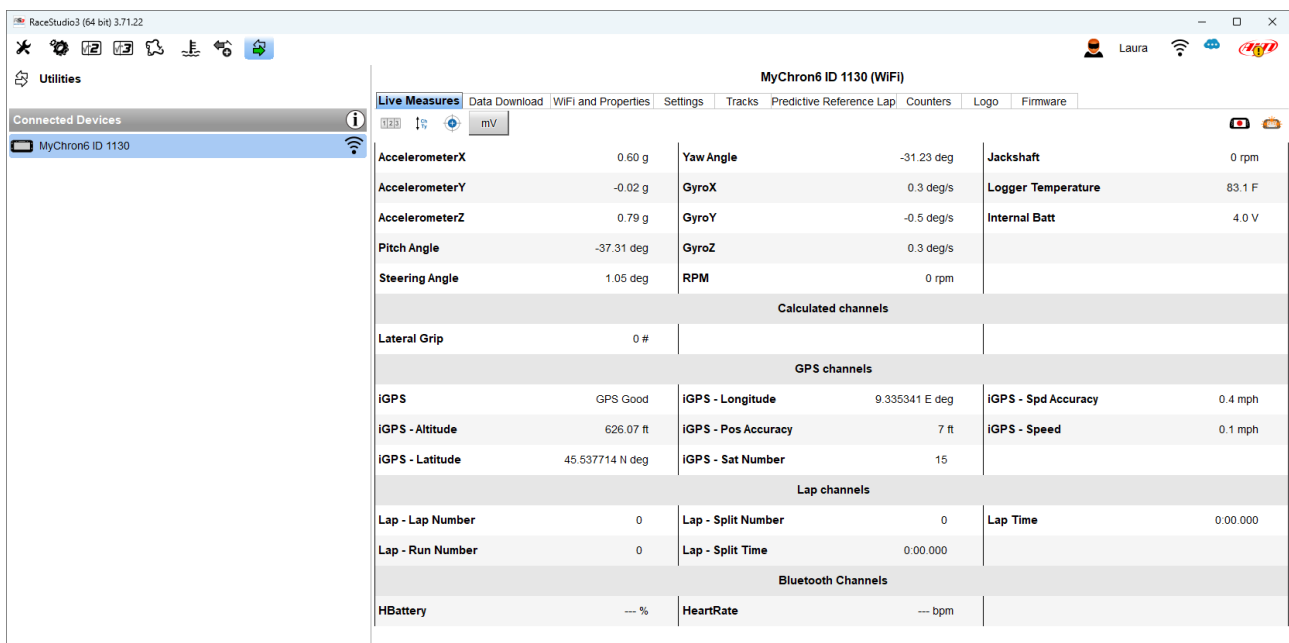

Once the connection is established you have these options:

- **Live Measures:** to check all MyChron6 channels;
- **Data Download:** to download data, see the related chapter;
- **WiFi and Properties:** to manage the Wi-Fi configuration – see the related chapter;
- **Settings to:**

- set date and time format
  - manage Time/Date synchronization
  - set backlight colour
  - enable/disable night vision and Bluetooth
  - enable/disable channel recording: it is possible to record it
  - set reference lap to select between Best lap of test, best lap of today, previous lap and user reference lap (see “Predictive reference lap” here below)
- **Settings** to:
  - **Tracks:** to manage the tracks stored in the device memory
  - **Predictive Reference Lap:** to manage the laps stored that can be selected as reference lap
  - **Counters:** to manage the device odometers; here you can reset the four user odometers as well as name them;
  - **Logo:** transmit/receive the logo that shows up when switching MyChron6 on; supported image format are JPEG or BMP; always use the most recent Windows™ versions (Windows8 or Windows10) whose graphic libraries are more updated
  - **Firmware:** to check or update your MyChron6 firmware version.

## 8 – Data download

Once MyChron6-PC connection is established activate “Download” tab to download sampled data.

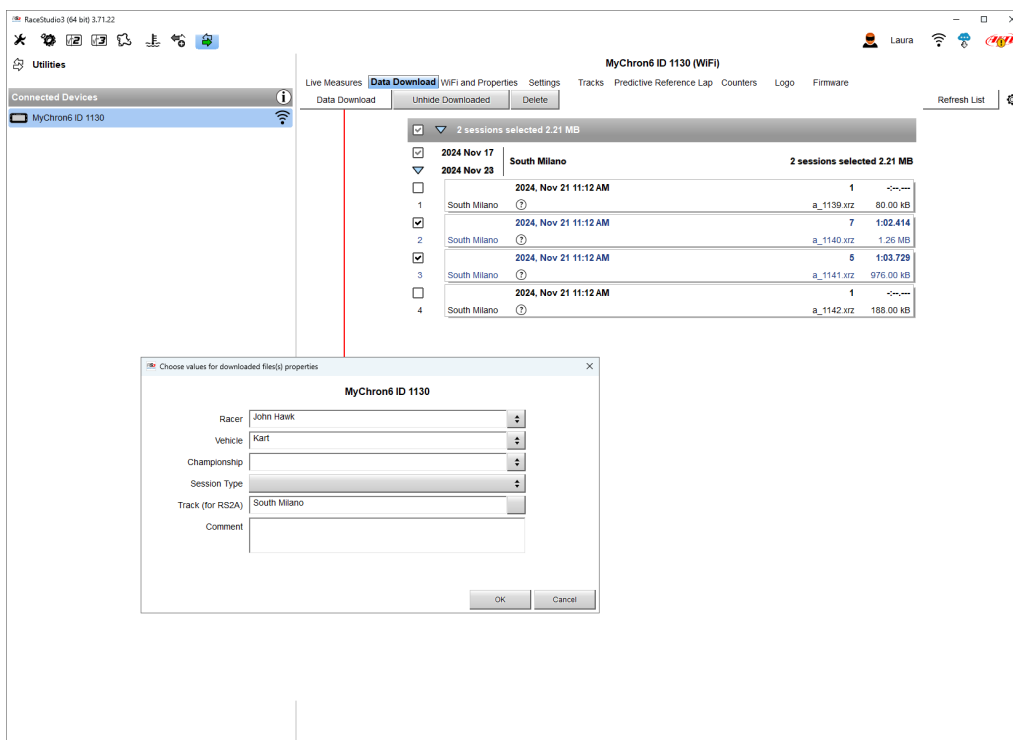

This page shows all information about the files stored in the system: number of laps, best lap, date/time and file dimensions.

Select one or more files and press “Download” to download and analyse them.

## 9- Analysis

When data have been downloaded press Analysis icon and Race Studio Analysis software will open showing this page. Select your file double clicking on it and start analysing it. A lot of pages, graphs and images will help you analysing your data.

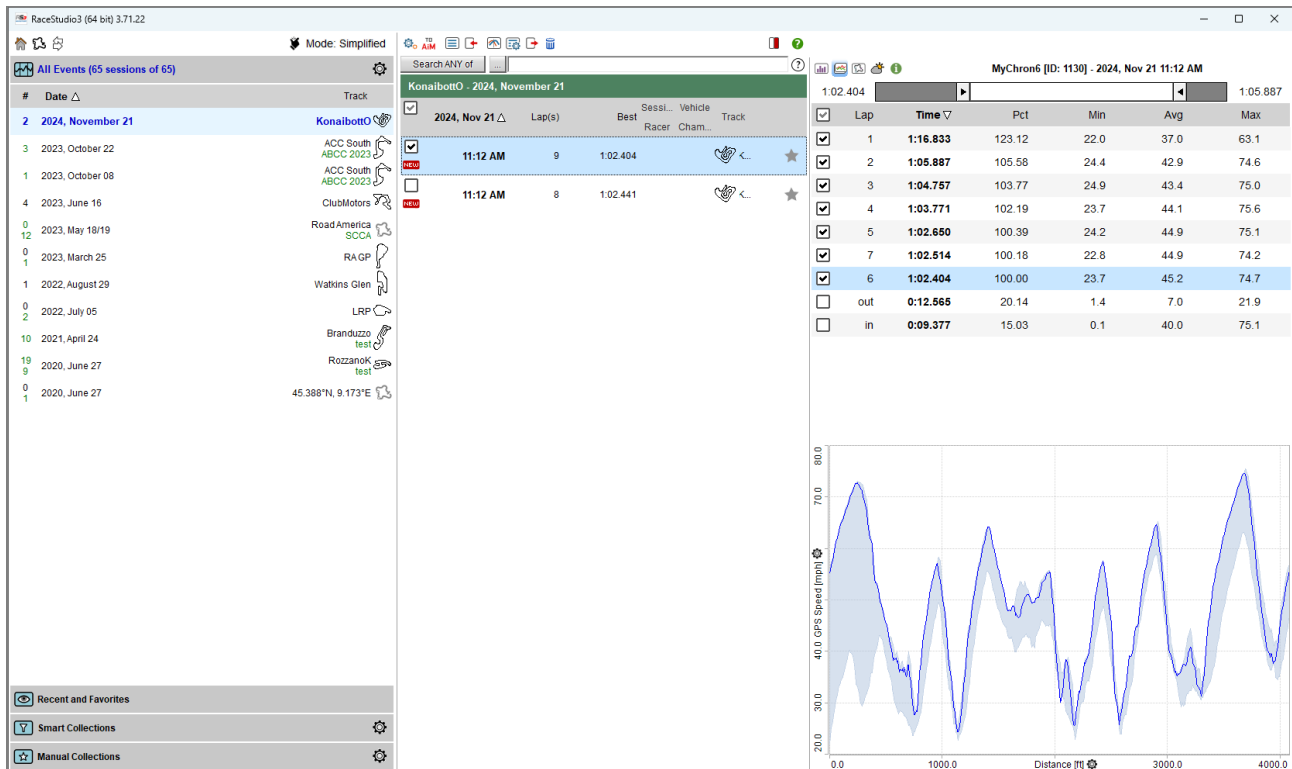

## 10 – Notification of new available versions

Our technicians and engineers are constantly working to improve both the firmware (the application that manages your device) and the software (the application you install on your PC).

Each time a new firmware and/or software version is available the icon here above appears with an arrow indicating that something is available for download (otherwise the icon only shows the cloud). Click it and freely download the new applications.

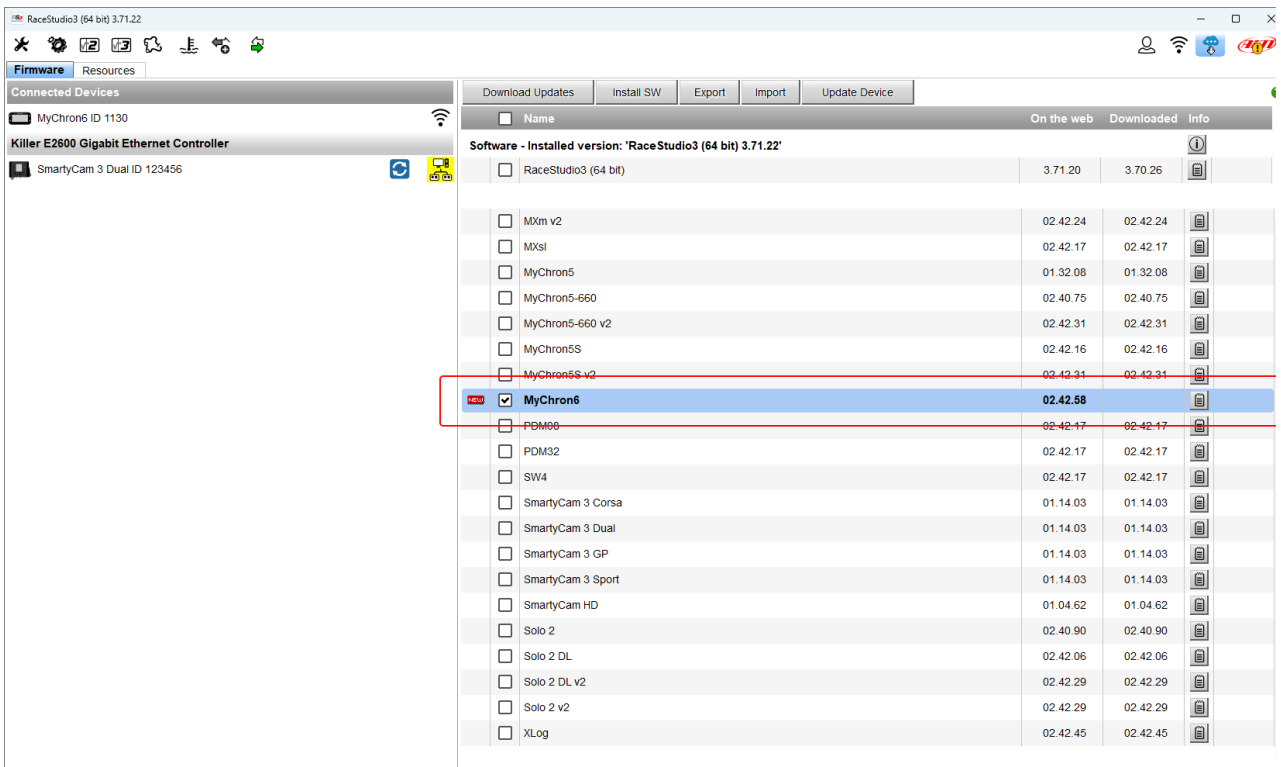

Once the new firmware has been downloaded, connect your device to the PC via Wi-Fi or via USB to perform a firmware upgrade. In a few seconds, the device is ready.

## 11 – Technical specifications and drawings

- Display Graphical
- Display Resolution 320x136 pixels
- Backlight 8 configurable RGB colours
- Shift lights/alarm LEDs 5+2 configurable RGB LEDs
- Integrated track database Yes
- Wi-Fi connection Yes
- Bluetooth connection Yes
- GPS frequency 25Hz
- Internal battery Rechargeable 2900 mAh Lithium Ion
- Battery duration Up to 20 hours
- External power 9-15V
- Temperature inputs 1 on MyChron6 – 2 on MyChron6 2T
- Supported temperature sensors Thermocouple/Thermo-resistor
- CAN connections 2
- Lap time Based on built in GPS  
From optical or magnetic receiver (optional)
  
- Internal memory 4Gb – more than 3.000 hours continuous logging
- Battery charger Included
- Body PA6 GS30%
- Dimensions 152.0x81.0x37 mm
- Weight 370g battery included
- Waterproof IP67
- Analysis software Race Studio Analysis freely downloadable from [www.aim-sportline.com](http://www.aim-sportline.com)



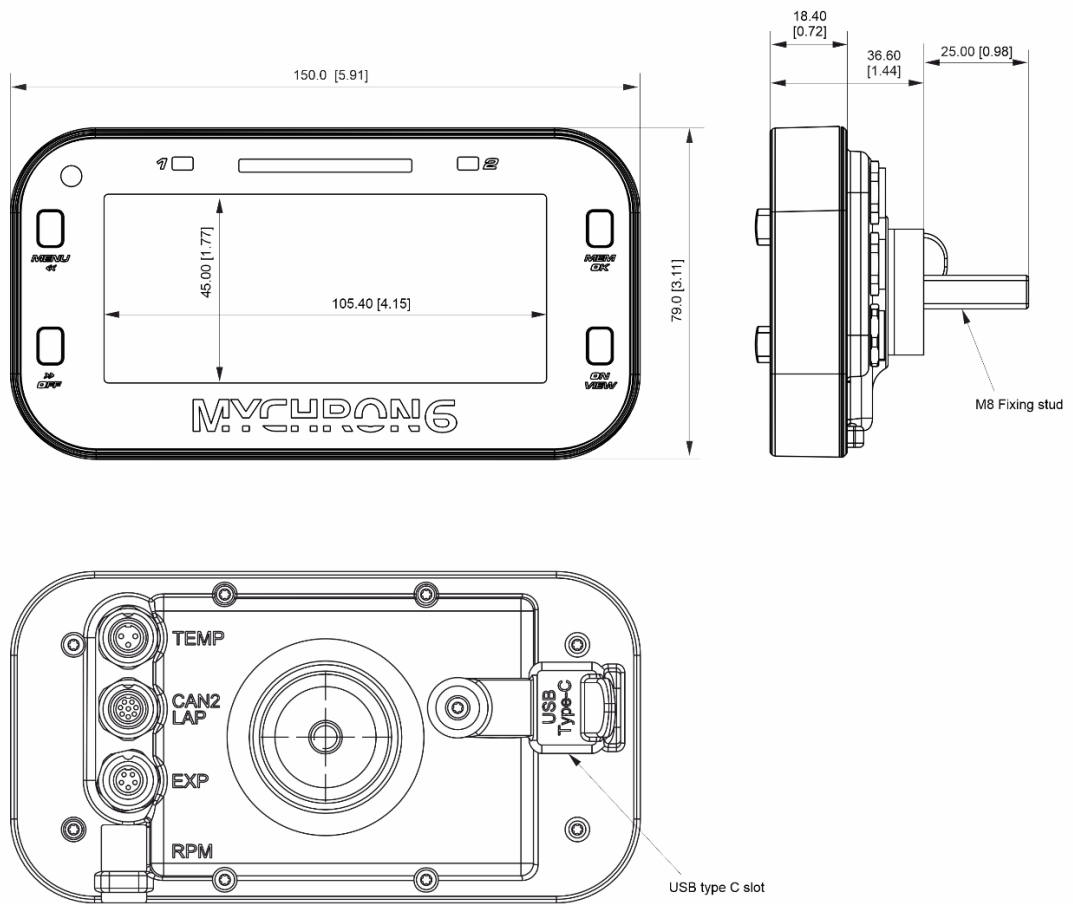

MyChron6/MyChron6 2T dimensions in mm [inches]



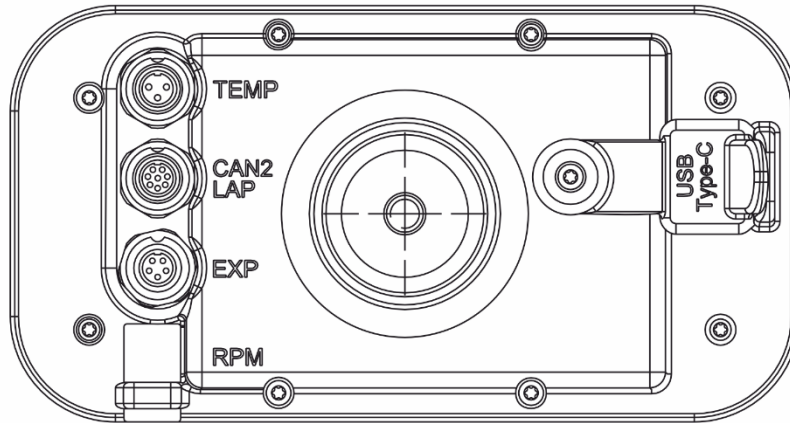



**MyChron6 pinout**

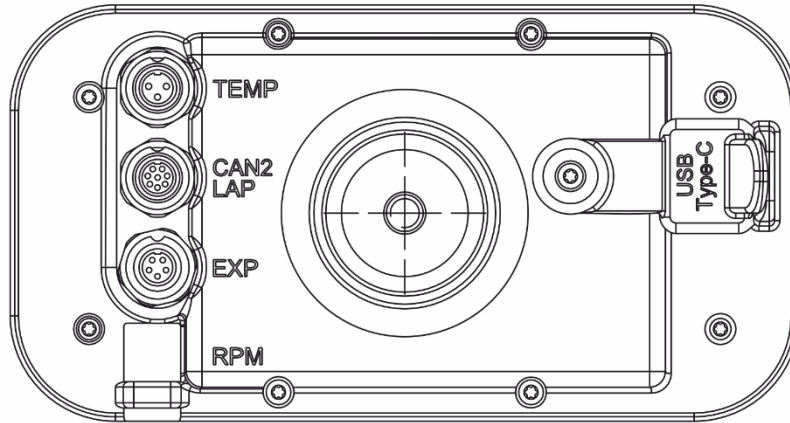

<p><b>TEMP</b> 3 pins Binder 712 female connector (external view)</p>	<p><b>CAN2 LAP</b> 8 pins Binder 712 female connector (external view)</p>	<p><b>EXP</b> 5 pins Binder 712 female connector (external view)</p>
 <p>1 - Thermocouple+ 2 - GND/Thermocouple - 3 - Thermoresistor</p>	 <p>1 - CAN2 H 2 - CAN2 L 3 - Digital Out 4 - Optical Lap 5 - +Vb Out 6 - GND 7 - Magnetic Lap 8 - Reserved</p>	 <p>1 - CAN+ Exp 2 - GND 3 - +Vbout CAN 4 - CAN- Exp 5 - +Vbext CAN</p>

MyChron6 2T



<b>TEMP</b> 7 pins Binder 712 female connector (external view)	<b>CAN2 LAP</b> 8 pins Binder 712 female connector (external view)	<b>EXP</b> 5 pins Binder 712 female connector (external view)
 <ul style="list-style-type: none"> <li>1 - Thermocouple 1+</li> <li>2 - Thermocouple 1-</li> <li>3 - Thermocouple 2+</li> <li>4 - GND/Thermocouple 2-</li> <li>5 - Thermoresistor 1</li> <li>6 - GND</li> <li>7 - Thermoresistor 2</li> </ul>	 <ul style="list-style-type: none"> <li>1 - CAN2 H</li> <li>2 - CAN2 L</li> <li>3 - Digital Out</li> <li>4 - Optical Lap</li> <li>5 - +Vb Out</li> <li>6 - GND</li> <li>7 - Magnetic Lap</li> <li>8 - Reserved</li> </ul>	 <ul style="list-style-type: none"> <li>1 - CAN+ Exp</li> <li>2 - GND</li> <li>3 - +Vbout CAN</li> <li>4 - CAN- Exp</li> <li>5 - +Vbext CAN</li> </ul>

Our website [www.aim-sportline.com](http://www.aim-sportline.com) is constantly updated. Please refer to it to download the last releases of our documentation.